

GIVI MOBILI ACESSÓRIOS PARA MÓVEIS LTDA.

Rua João Bettega, 4.800, Módulo V - CEP 81350-000 - CIC - Curitiba - PR

Fone: (41) 3906-8080 FAX: (41) 3906-8008

www.givimobili.com.br

SISTEMA DE ELEVAÇÃO PARA UMA PORTA

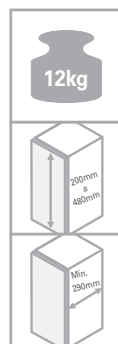

- Peso máximo da porta 12kg;
- Altura mínima da porta de 200mm;
- Altura máxima da porta de 480mm;
- Profundidade mínima de módulo de 290mm.

Componentes

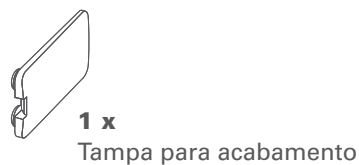
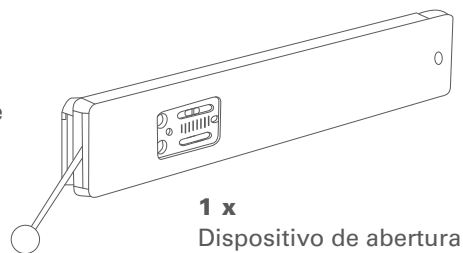
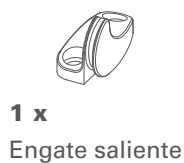

Medidas para instalação

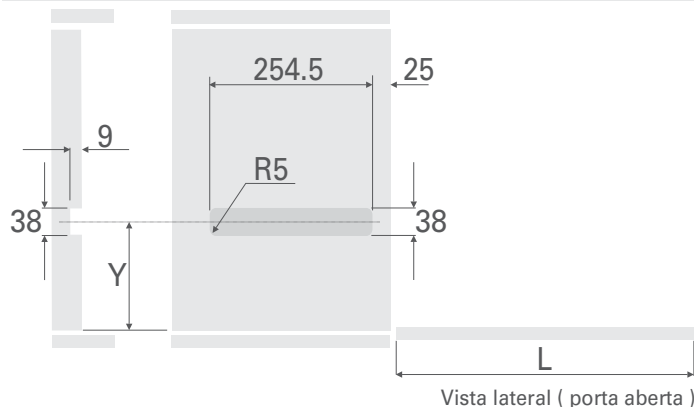

Medidas para furação das portas

L	Y	H	V
altura da porta 200 a 330	122	104+A	12+B
330 a 430	148	130+A	12+B
430 a 480	158	140+A	12+B

Recobrimento

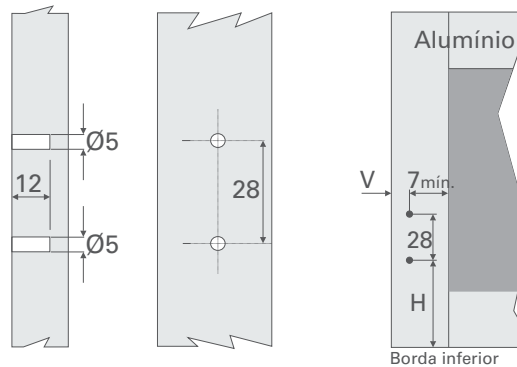
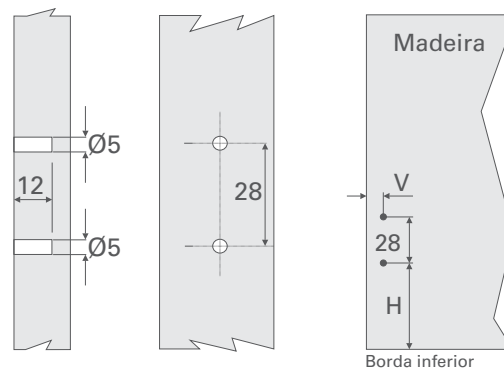
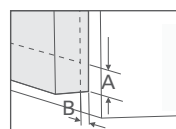

Fixação do engate

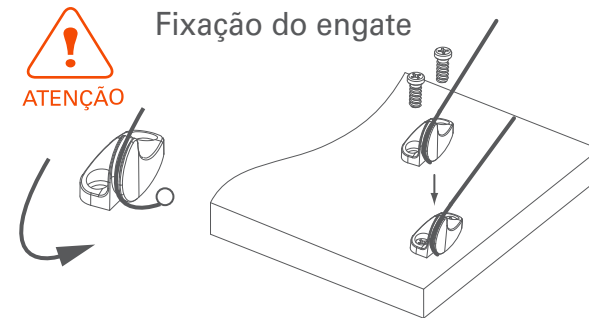

Fixação do sistema

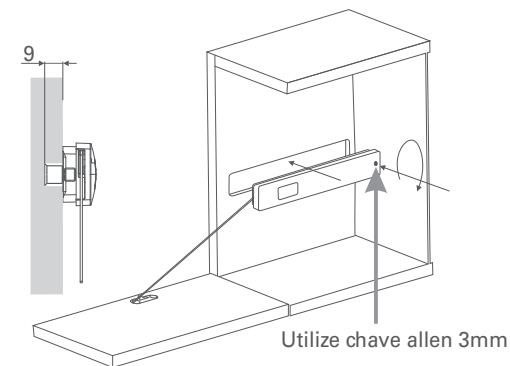

O peso e a posição do puxador podem influenciar no funcionamento do mecanismo.



Regulagens

Regulagem da **força** de abertura da porta

Utilize chave Philips 2



Regulagem do **ângulo** de abertura da porta

Utilize chave Philips 2

